

# Lecture 5: Microwind/DCSH

CSCI 5330

Digital CMOS VLSI Design

**Instructor:** Saraju P. Mohanty, Ph. D.

**NOTE:** The figures, text etc included in slides are borrowed from various books, websites, authors pages, and other sources for academic purpose only. The instructor does not claim any originality.



# Lecture Outline

- Microwind Tool
- DCSH Tool
- Silicon Tool

## Source:

1. <http://www.microwind.org>
2. Microwind Based Design ([http://vsp2.ecs.umass.edu/vspg/658/TA\\_Tools/microwind/Microwind.html](http://vsp2.ecs.umass.edu/vspg/658/TA_Tools/microwind/Microwind.html))



# Microwind and DSCH

- **Microwind** is a tool for designing and simulating circuits at layout level. The tool features full editing facilities (copy, cut, past, duplicate, move), various views (MOS characteristics, 2D cross section, 3D process viewer), and an analog simulator.
- **DSCH** is a software for logic design. Based on primitives, a hierarchical circuit can be built and simulated. It also includes delay and power consumption evaluation.
- **Silicon** is for 3D display of the atomic structure of silicon, with emphasis on the silicon lattice, the dopants, and the silicon dioxide.



# Microwind and DSCH ...

- Download the followings from <http://www.microwind.org/>
  - Microwind3
  - DSCH3
  - User Manual: [http://intrade.insa-toulouse.fr/~etienne/microwind/manual\\_lite.pdf](http://intrade.insa-toulouse.fr/~etienne/microwind/manual_lite.pdf)
- Installation and Use:
  - Unzip the files above to be able to work with Microwind.
  - Read the reference manual for the software.
  - Double click on Microwind3.exe to start the layout editor or on Dsch3.exe to start the schematic editor.

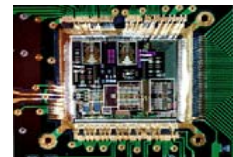

# Tools from Microwind

<http://www.microwind.org/>

- Microwind
- DSCH
- Microwind3 Editor
- Microwind 2D viewer
- Microwind 3D viewer
- Microwind analog simulator
- Microwind tutorial on MOS devices
- View of Silicon Atoms



# Microwind and DSCH : NOR Example

- We will learn both the design flow and the CAD tools.
- The specifications we are going to see may be different for different foundry and technology.
- Design Example (3 Levels) : NOR Gate
  - Logic Design
  - Circuit Design
  - Layout Design



# Microwind / DSCH NOR Example: Logic

- Open the Schematic Editor in Microwind (DSCH3). Click on the transistor symbol in the Symbol Library on the right.
- Instantiate NMOS or PMOS transistors from the symbol library and place them in the editor window.

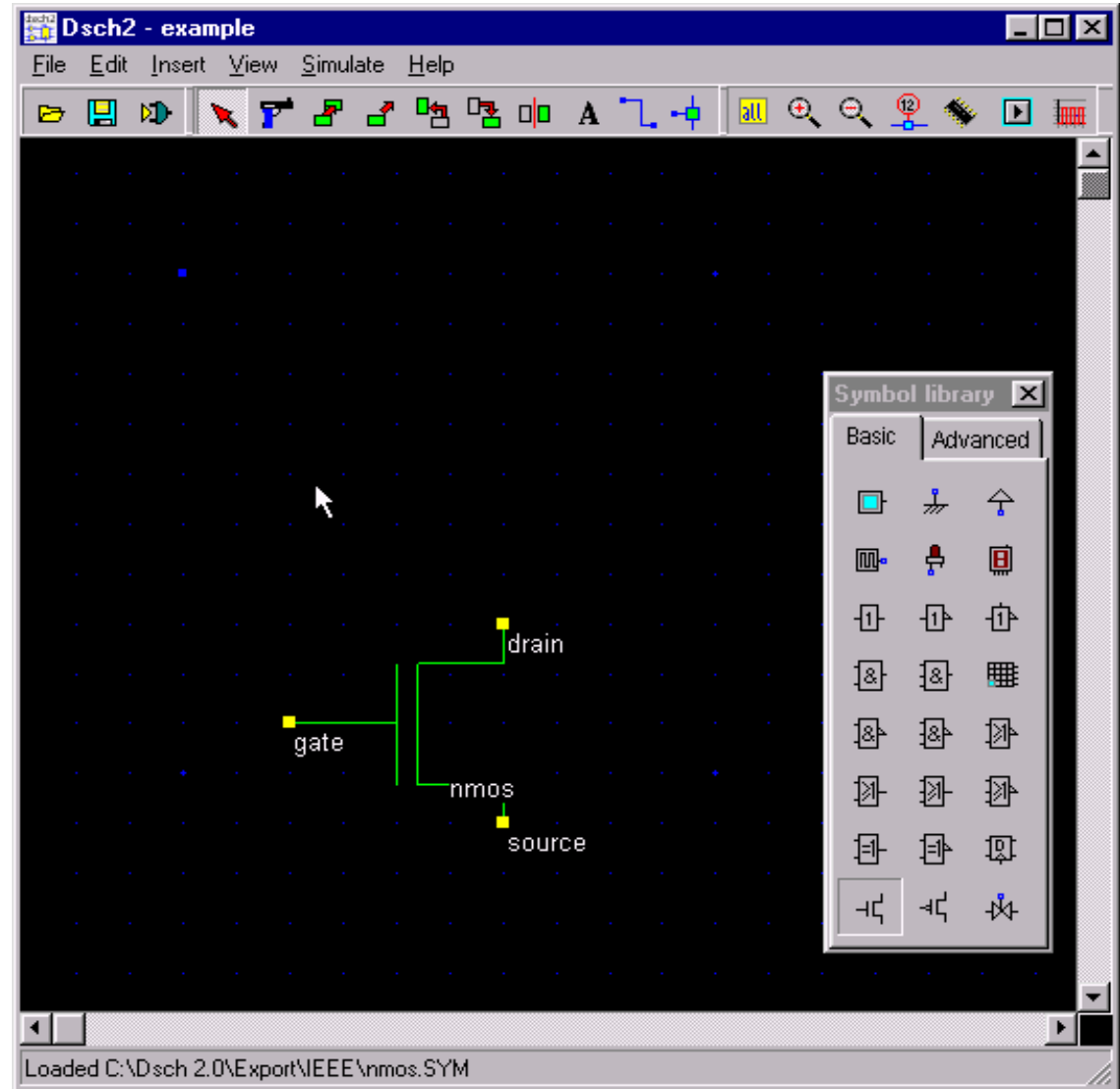

# Microwind / DSCH NOR Example: Logic

- Instantiate 2 NMOS and 2 PMOS transistors.
- Connect the drains and sources of transistors.

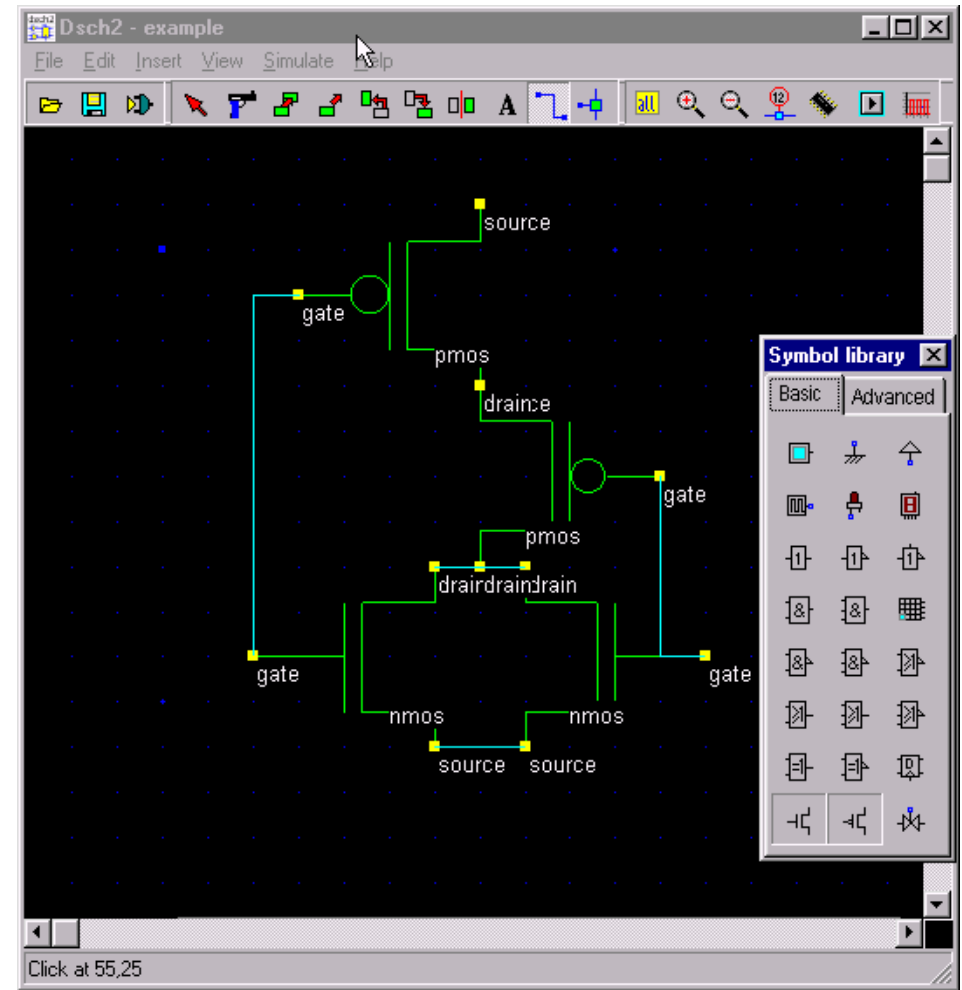
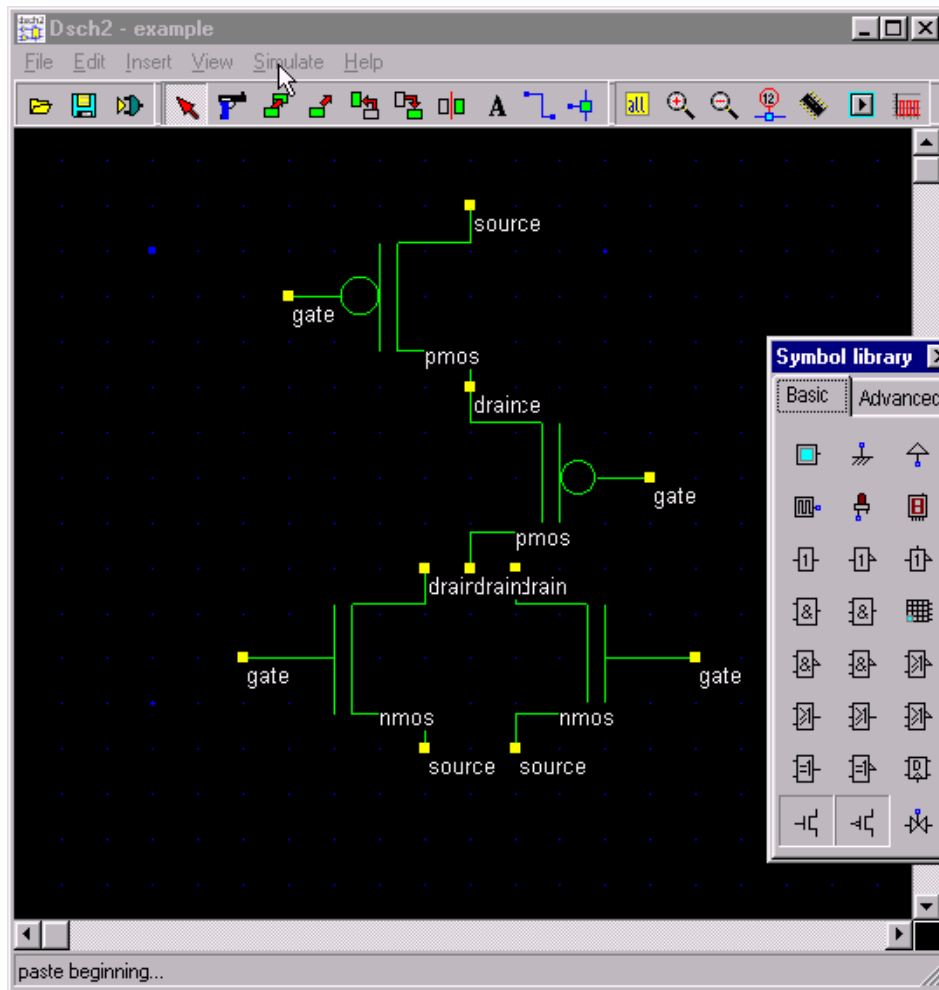



# Microwind / DSCH NOR Example: Logic

- Connect Vdd and GND to the schematic.
- Connect input button and output LED.

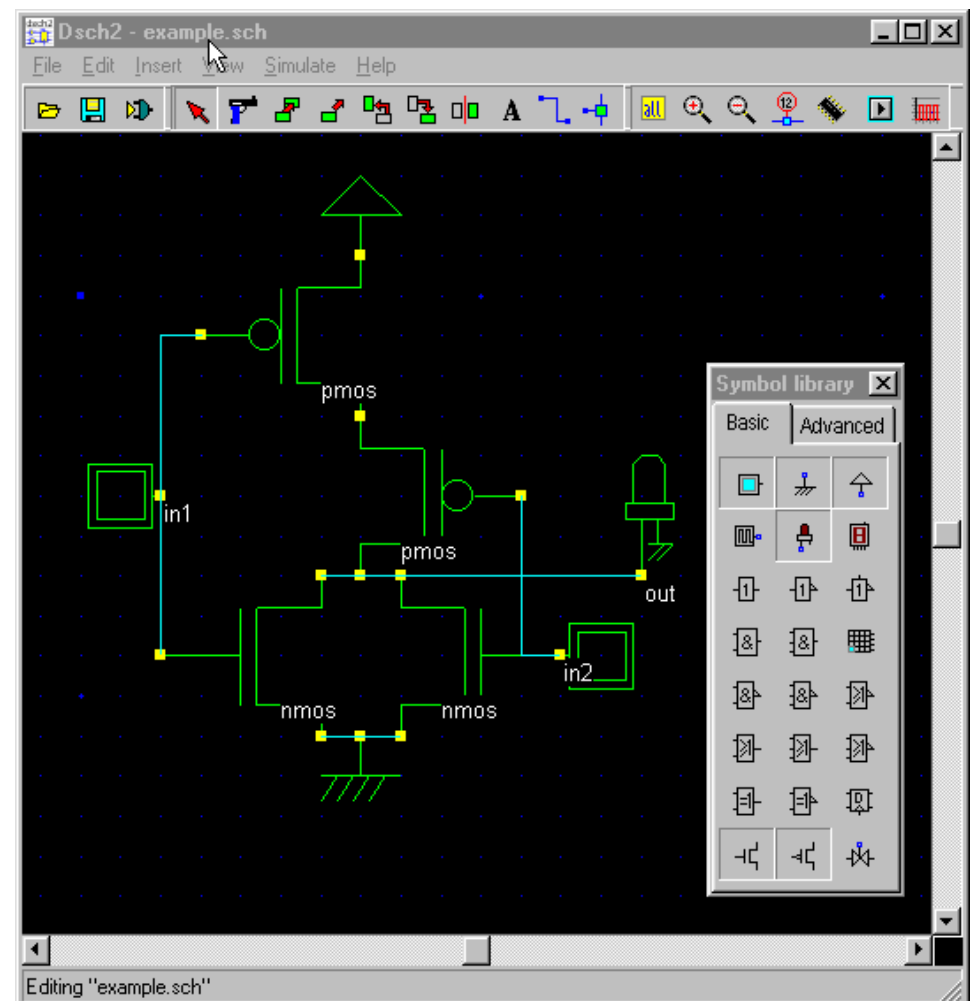
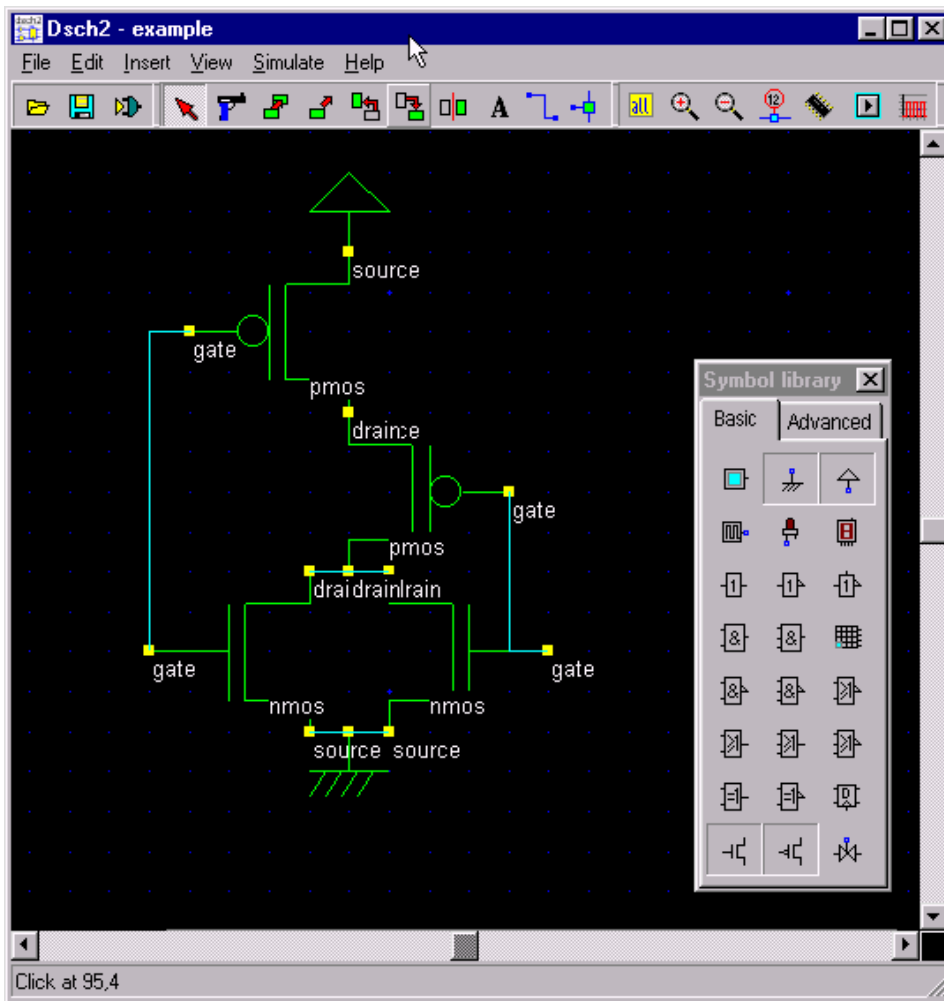

# Microwind / DSCH NOR Example: Logic

- You now have NOR schematic ready.
- Use your logic simulator to verify the functionality of your schematic.
- The next step is to simulate the circuit and check for functionality.
- Click on, Simulate -> Start simulation.
- This brings up a Simulation Control Window.
- Click on the input buttons to set them to 1 or 0. Red color in a switch indicates a '1'.

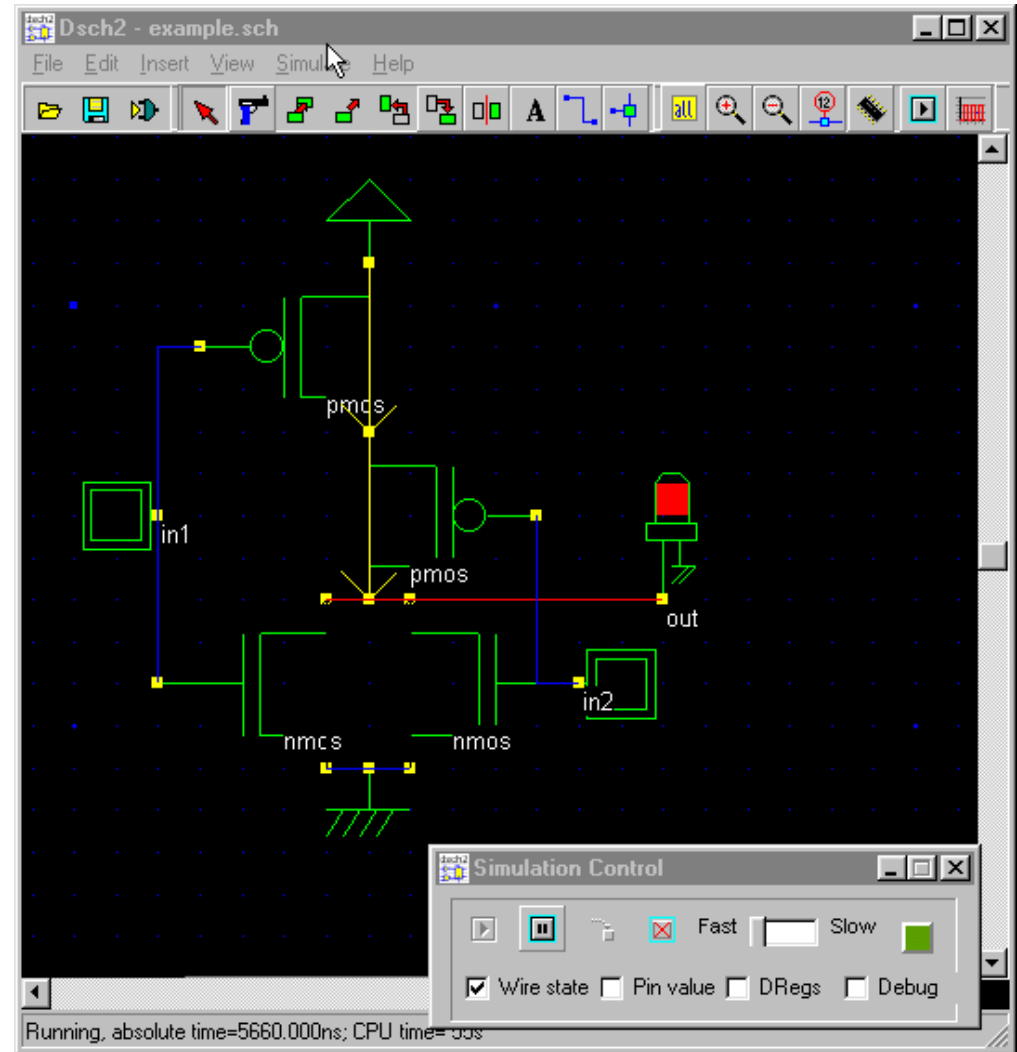

# Microwind / DSCH NOR Example: Logic

- Inputs: 0 0

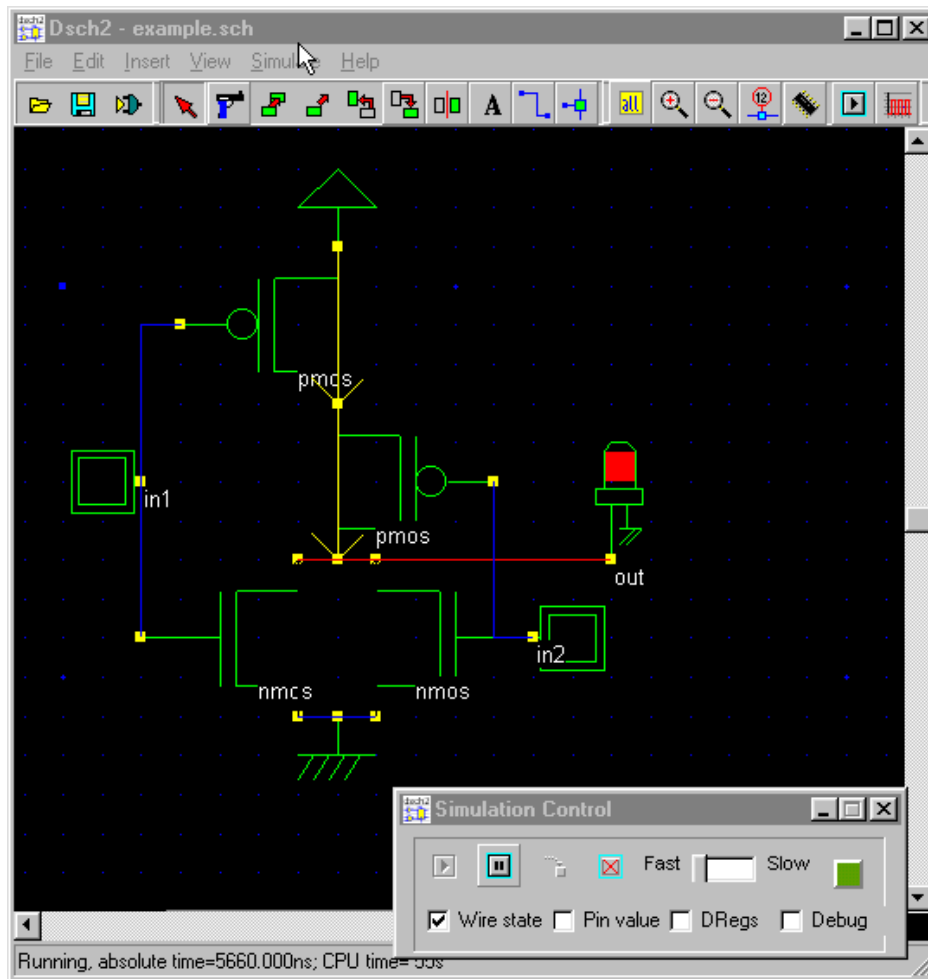

- Inputs: 0 1

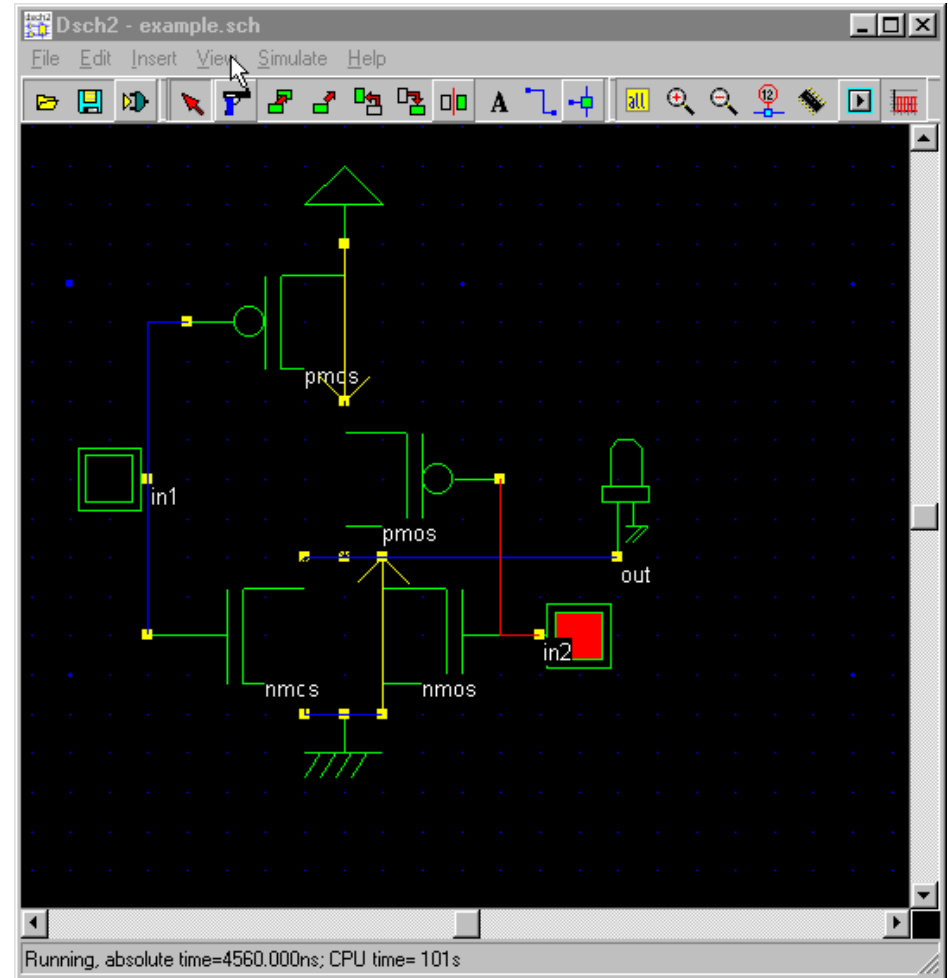

# Microwind / DSCH NOR Example: Logic

- Inputs: 1 0

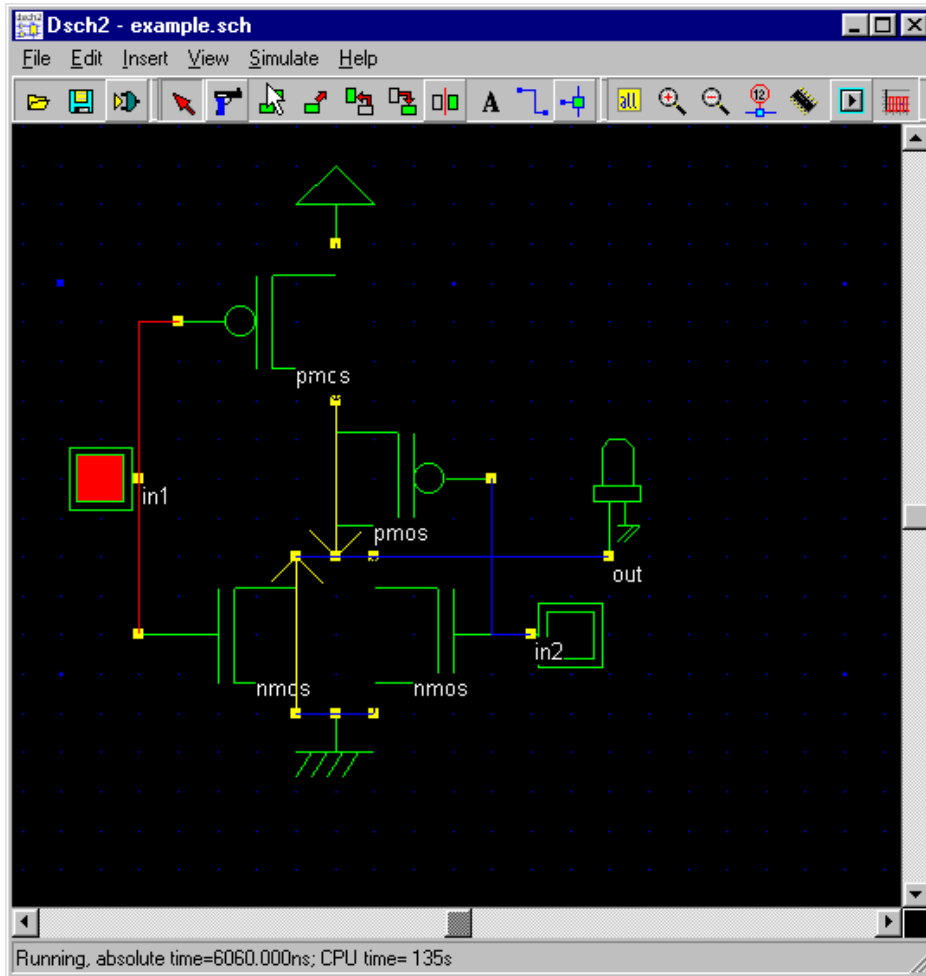

- Inputs: 1 1

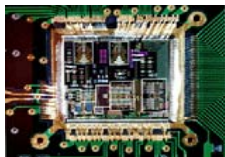
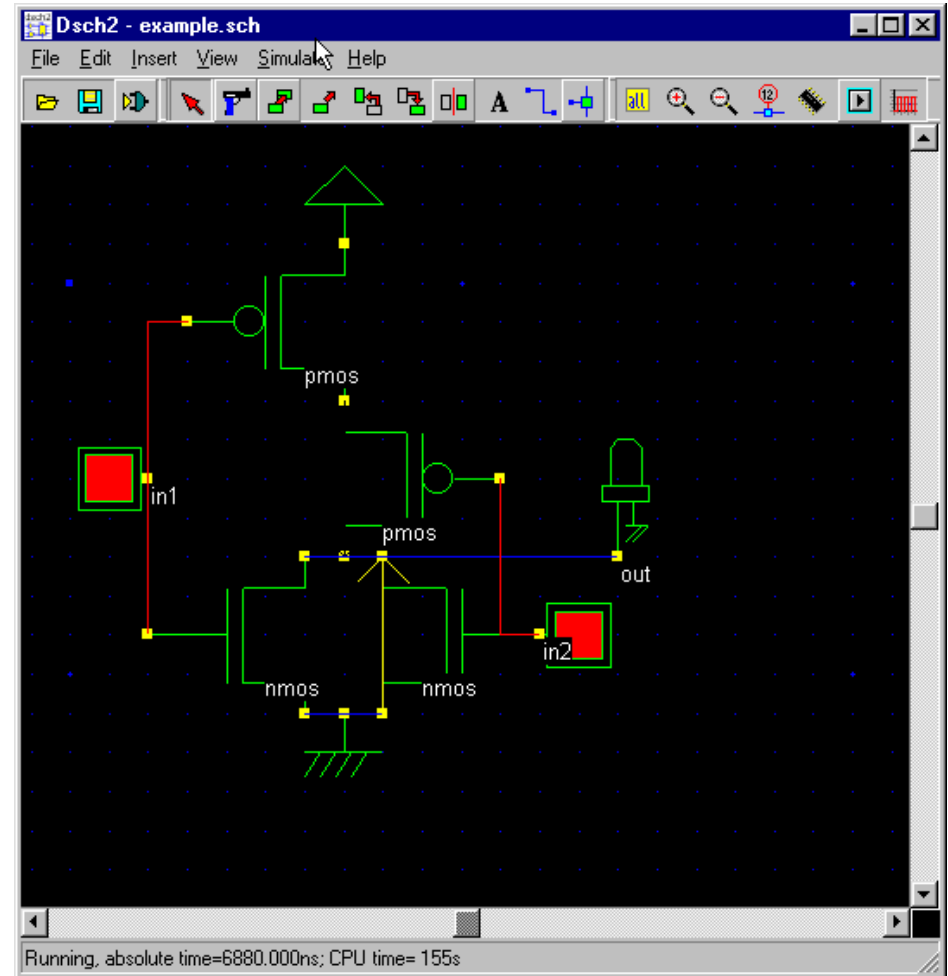

# Microwind / DSCH NOR Example: Logic

- The simulation output can be observed as a waveform after the application of the inputs as above. Click on the timing diagram icon in the icon menu to see the timing diagram of the input and output waveforms.

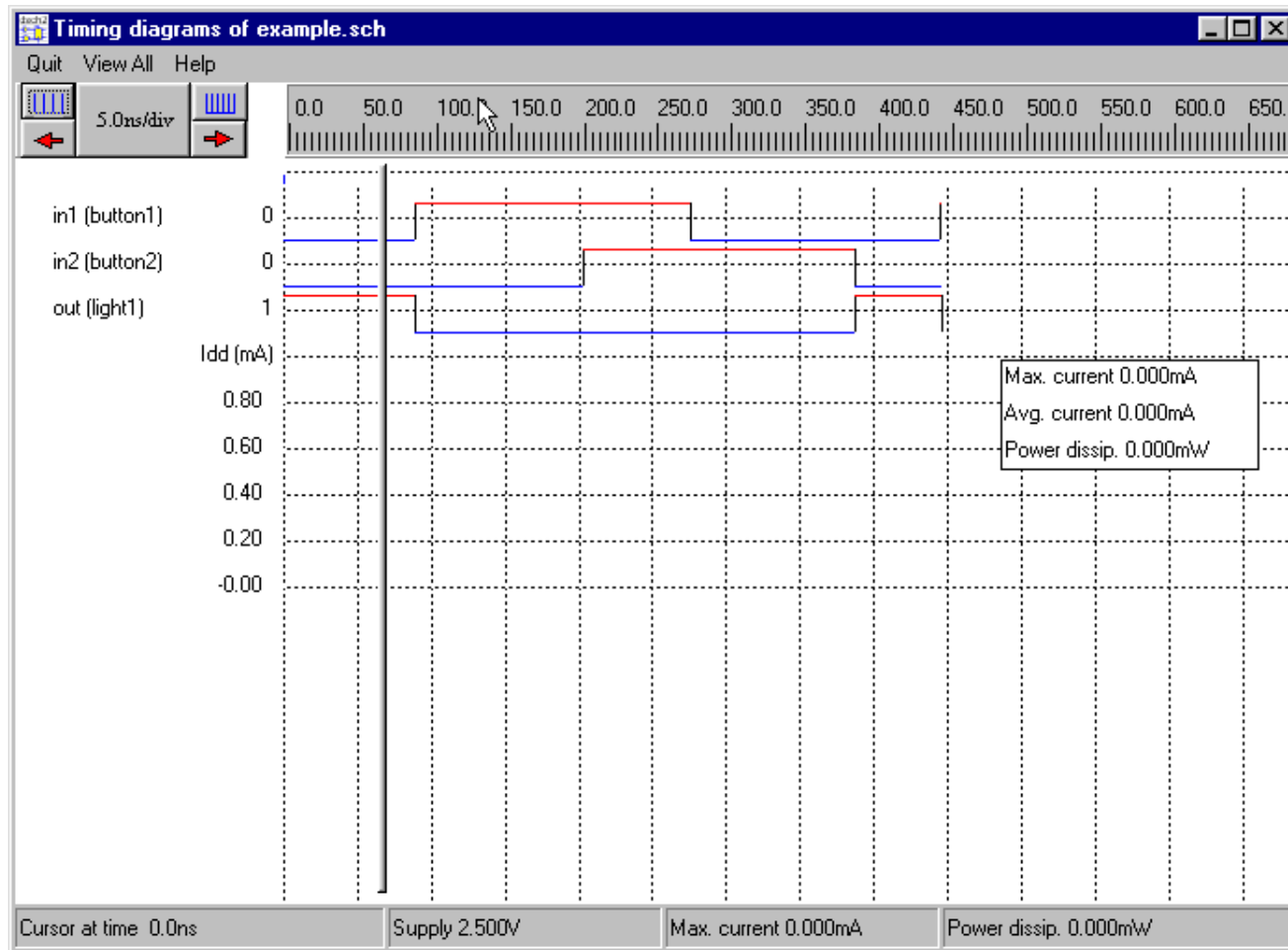

# Microwind / DSCH NOR Example: Circuit

- Simulate your system with your hand calculated transistor sizes.

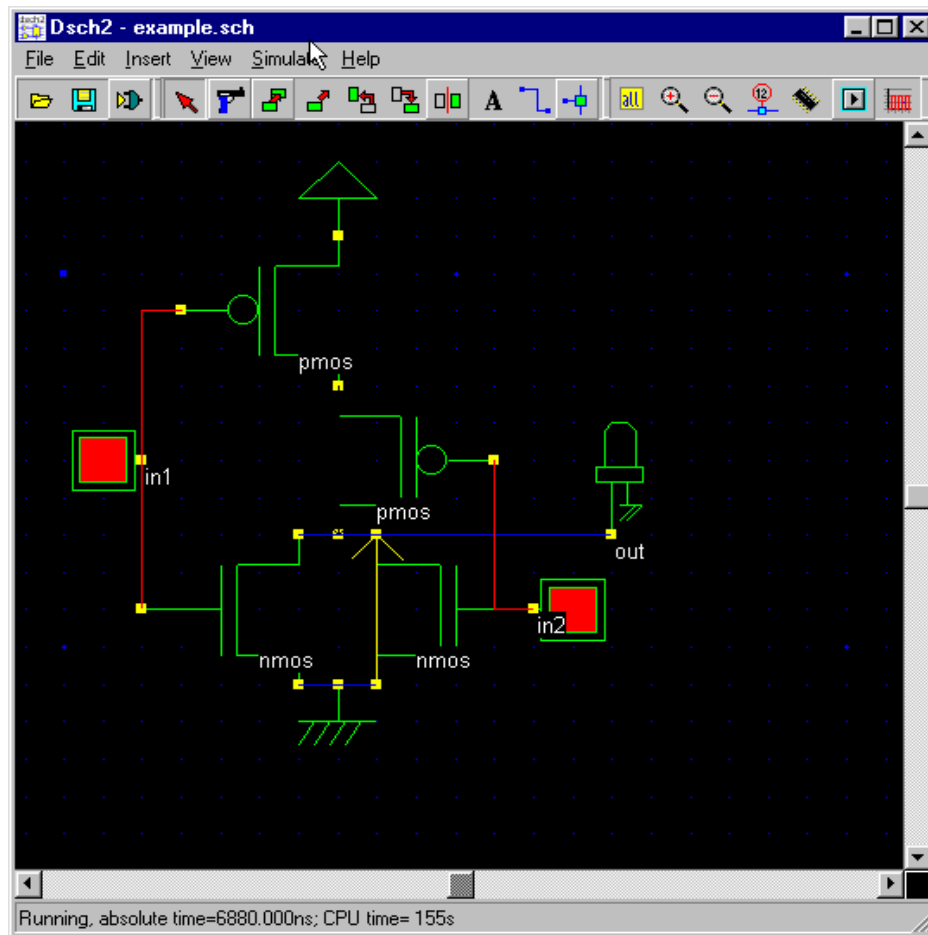

- Click *File -> Make Verilog File*. The Verilog, Hierarchy and Netlist window appears. This window shows the verilog representation of NOR gate. Click OK to save the Verilog as a .txt file.

Verilog, Hierarchy and Netlist

Verilog | Hierarchy | Netlist

```
// DSCH 2.2a , Flat Verilog
// 9/23/01 5:34:07 PM
// example.sch

module example( in1,in2,out);
input in1,in2;
output out;
wire i0w1;
nmos nmos1(out,vss,in1);
nmos nmos2(out,vss,in1);
pmos pmos1(out,i0w1,in2);
pmos pmos2(i0w1,vdd,in1);
endmodule

// Simulation parameters
// in1 CLK 10 10
// in2 CLK 20 20
```

Verilog Description

Hierarchy Verilog

Flat Verilog for Microwind2

Information

Module name (8 char. max)

example

Append simulation informations

The Verilog file has 17 lines

The design includes 9 symbols

The circuit has 5 nodes

OK

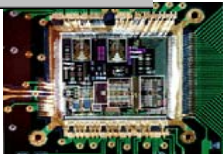

# Microwind / DSCH NOR Example: Circuit

- Open the layout editor window in Microwind. Click *File* -> *Select Foundry* and select *X.rul*. This sets your layout designs in X technology.
- Click on *Compile* -> *Compile Verilog File*. An *Open Window* appears. Select the *.txt* verilog file saved before and open it.

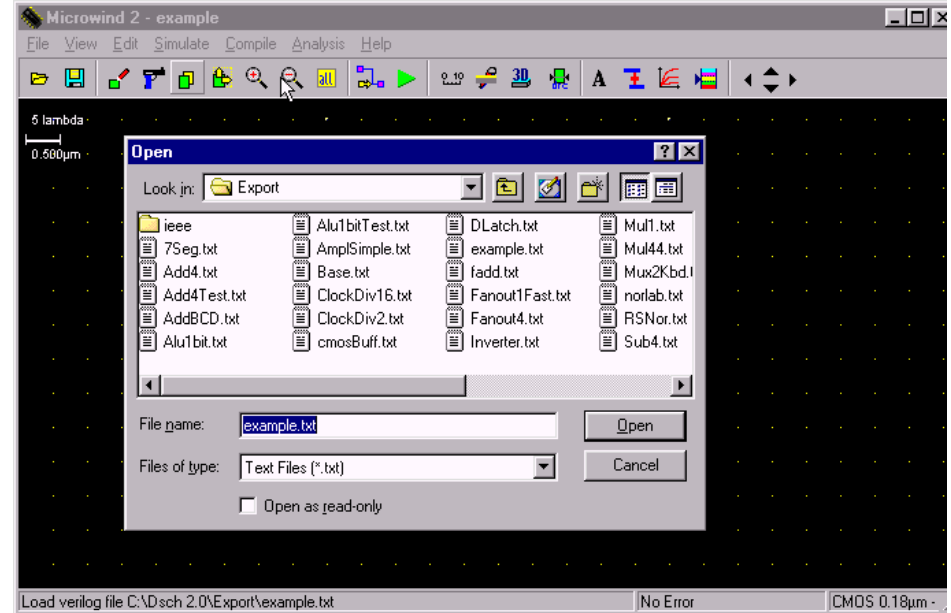
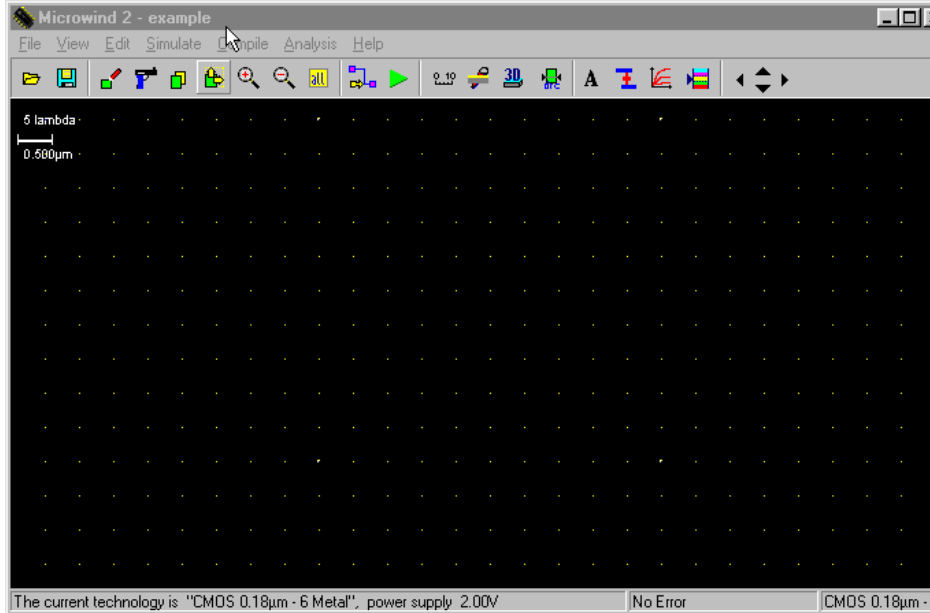

# Microwind / DSCH NOR Example: Circuit

- After selecting the .txt file, a new window appears called Verilog file.
- Click on Size on the right top menus. This shows up the NMOS and PMOS sizes. Set the sizes according to choice.

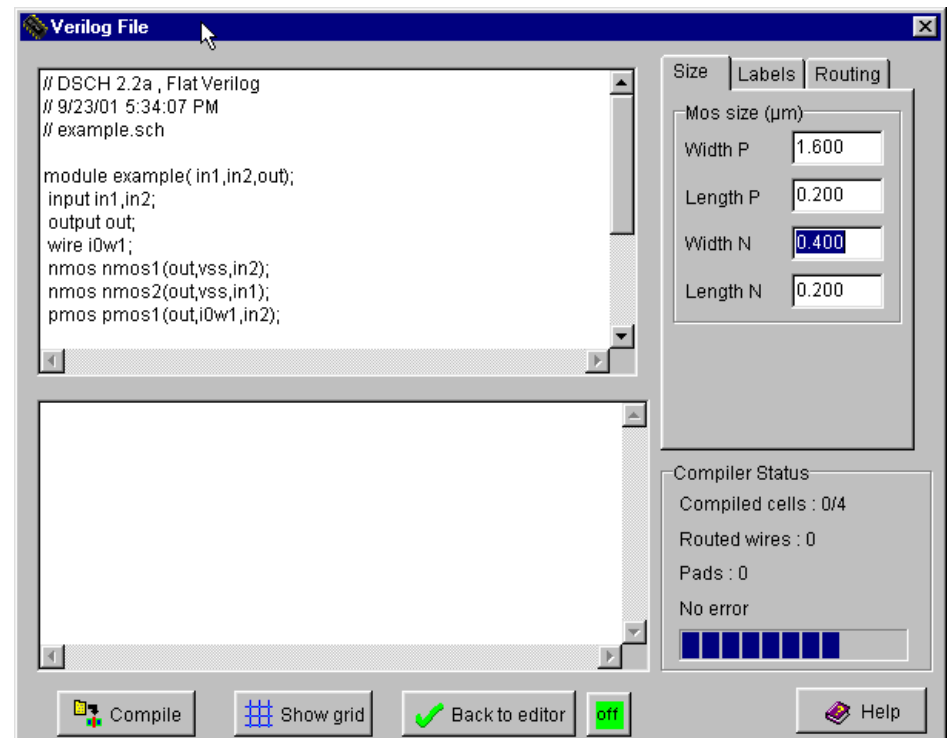
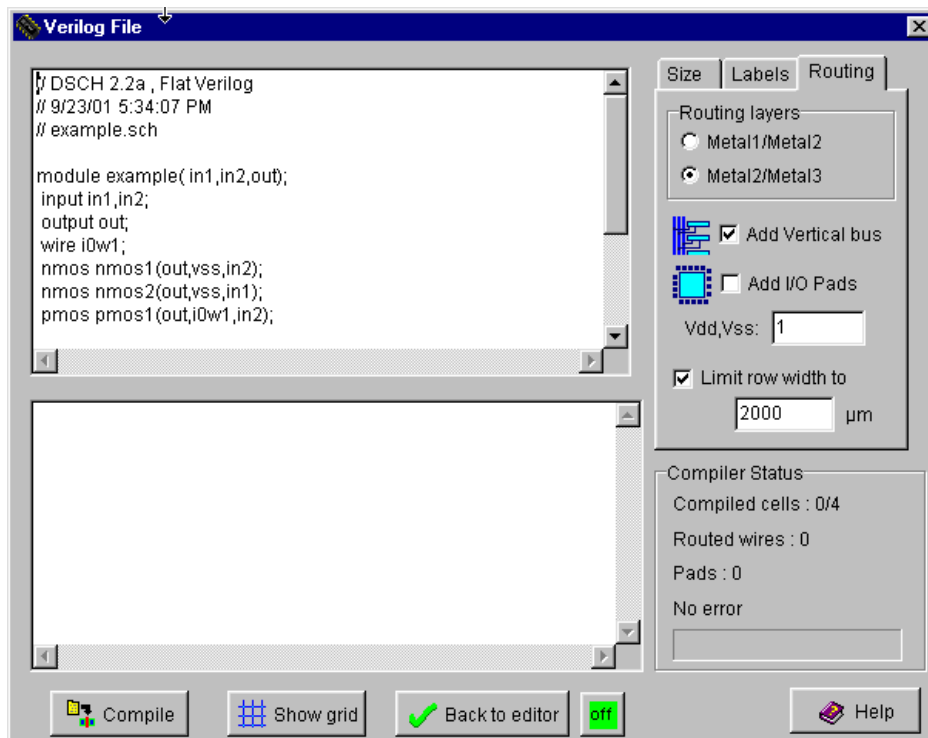



# Microwind / DSCH NOR Example: Circuit

- Click Compile and then Back to editor in the Verilog File Window. This creates a layout in layout editor window using automatic layout generation procedure.
- Add a capacitance to the output of the design. The value of the capacitance depends on your choice.

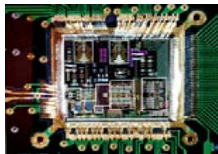
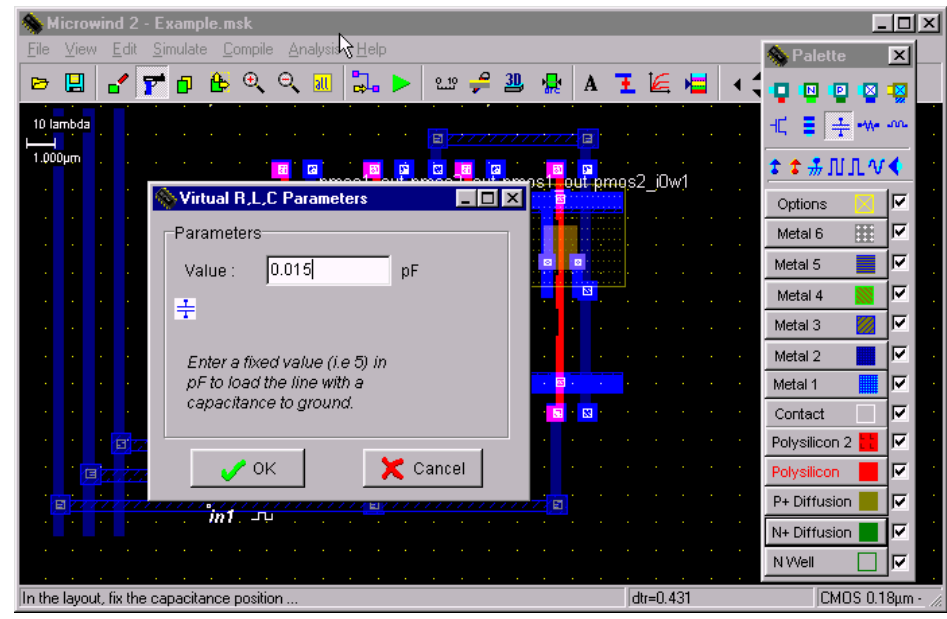
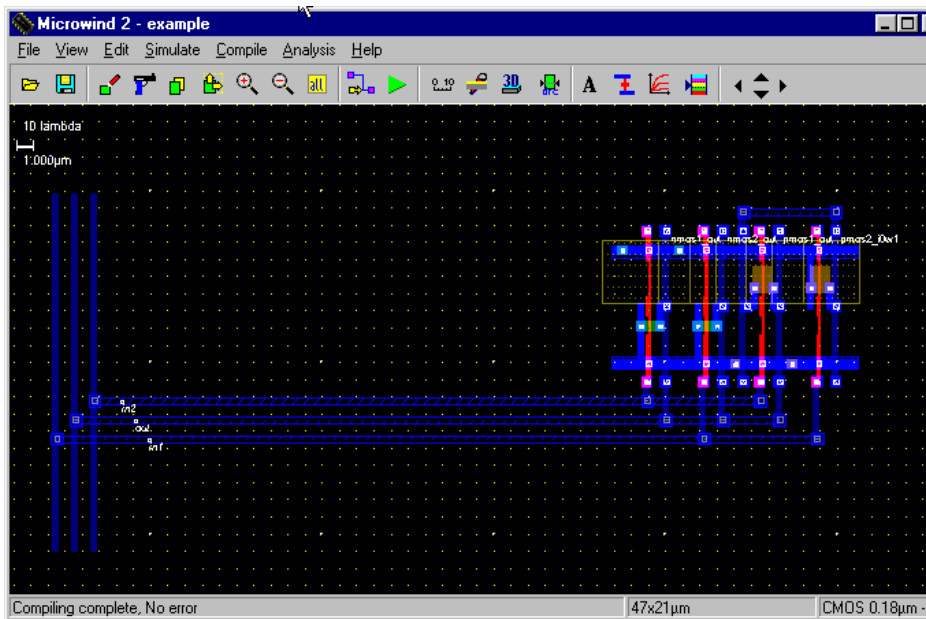

# Microwind / DSCH NOR Example: Circuit

- Click on OK. The capacitance is shown on the left bottom corner with a value of 0.015fF.
- Click on the label marked In1. A window appears. Click on the *Pulse* option in the window. Insert a 01 sequence for that specific input and click on *Insert*. Then click on *Assign*. Perform this assignment on the other inputs.

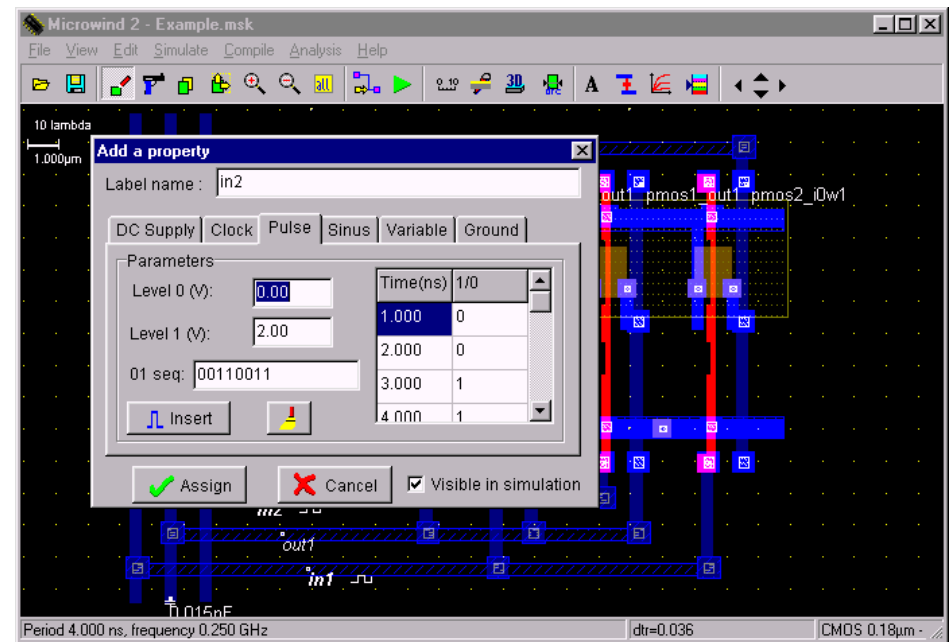
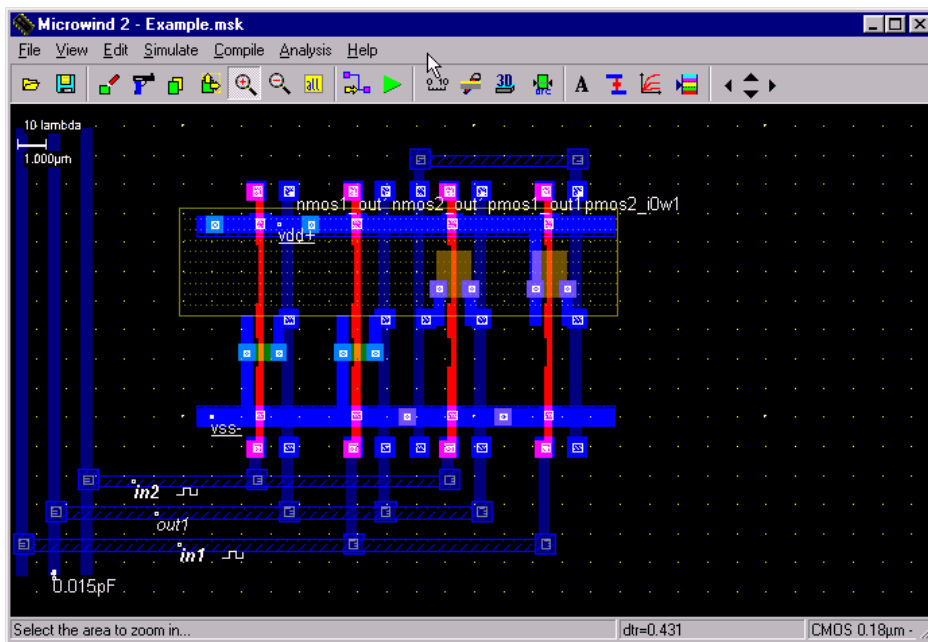

# Microwind / DSCH NOR Example: Circuit

- Click *Simulate* -> *Run simulation*. A simulation window appears with inputs and output, shows the t<sub>phl</sub>, t<sub>plh</sub> and t<sub>p</sub> of the circuit. The power consumption is also shown on the right bottom portion of the window.
- If you are unable to meet the specifications of the circuit change the transistor sizes. Generate the layout again and run the simulations till you achieve your target delays.

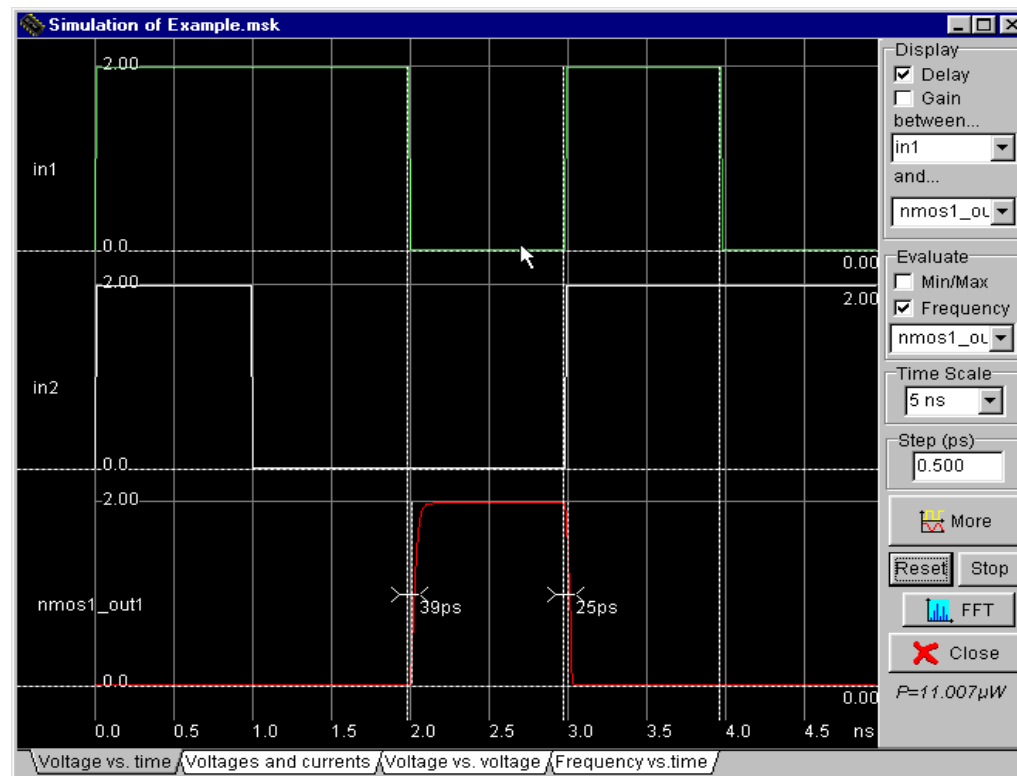

# Microwind / DSCH NOR Example: Layout

- Design the layout manually
- Open the layout editor window in Microwind. Click *File* -> *Select Foundry* and select *X.rul*
- Vdd and GND rails are of Metal1. The top rail is used as Vdd and the bottom one as GND. Click on Metal 1 in the palette and then create the required rectangle in the layout window.

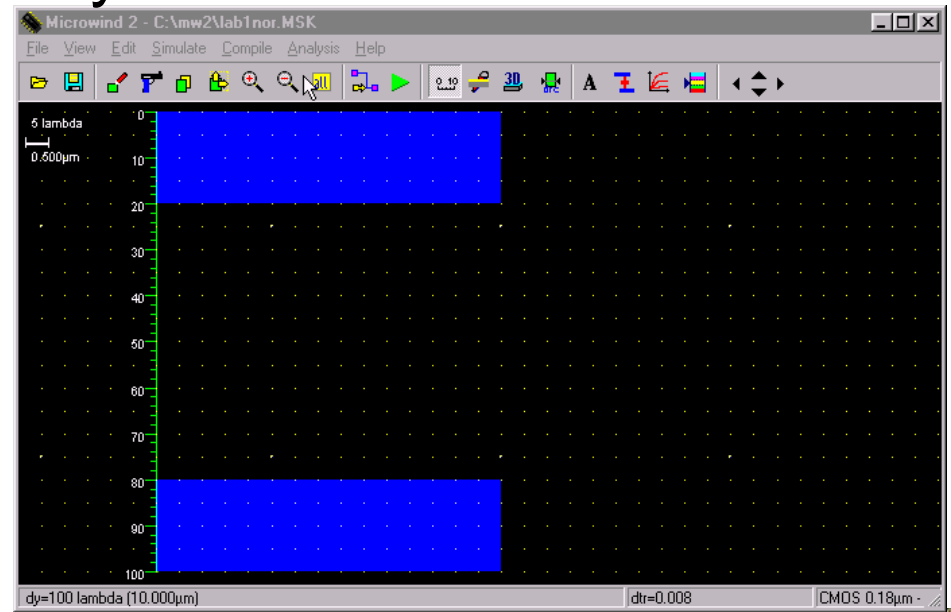
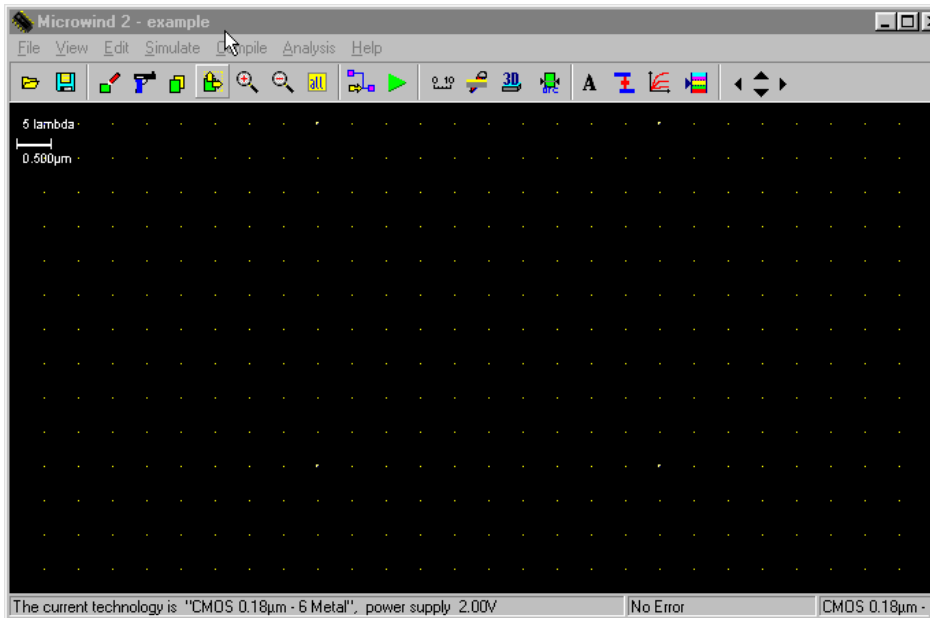

# Microwind / DSCH NOR Example: Layout

- The next step is to build the NMOS transistors. Click on the transistor symbol in the palette. Set the W, L of the transistor.
- Then click on Generate device. The source of the transistor is connected to the GND rail.

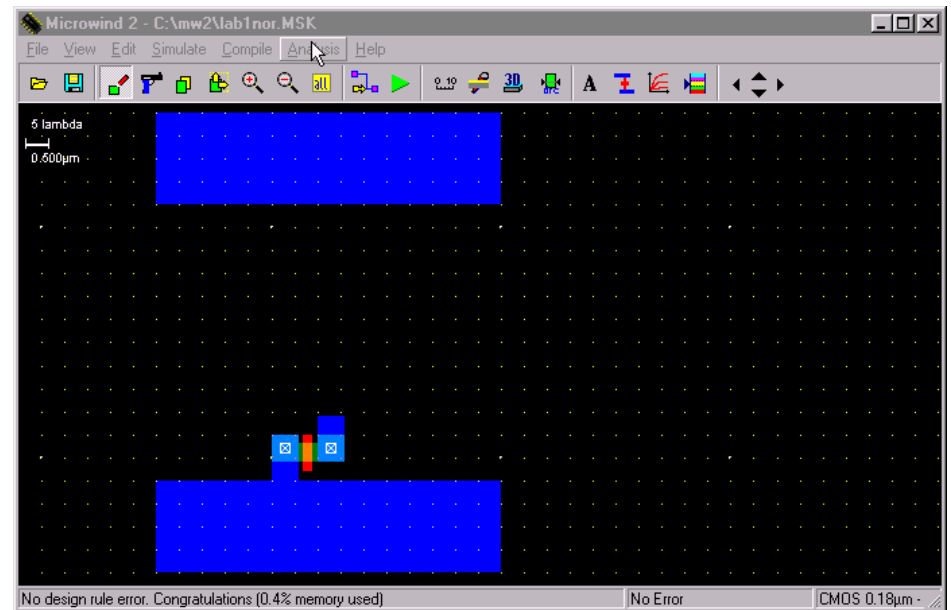
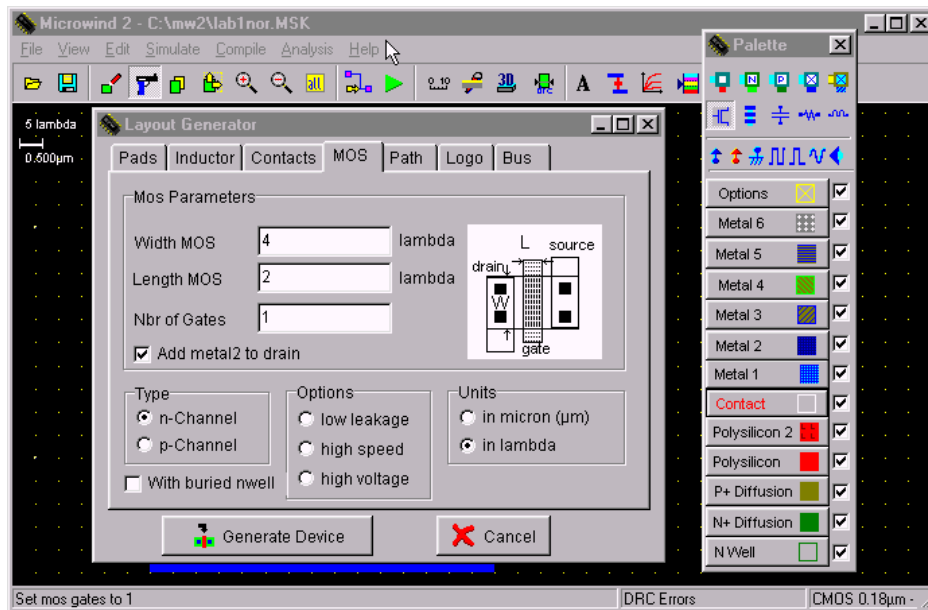

# Microwind / DSCH NOR Example: Layout

- Create another NMOS and place it in parallel to the first NMOS device. We share the two devices' drain diffusions. A DRC check can be run by clicking on *Analysis* -> *Design Rule Checker*.
- The next step is to place two PMOS transistors in series.

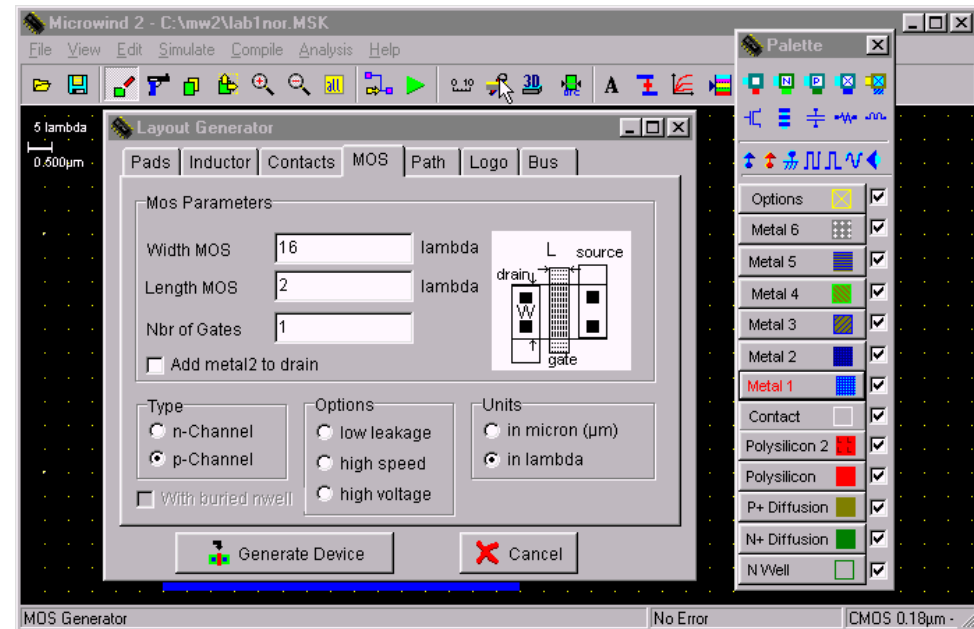
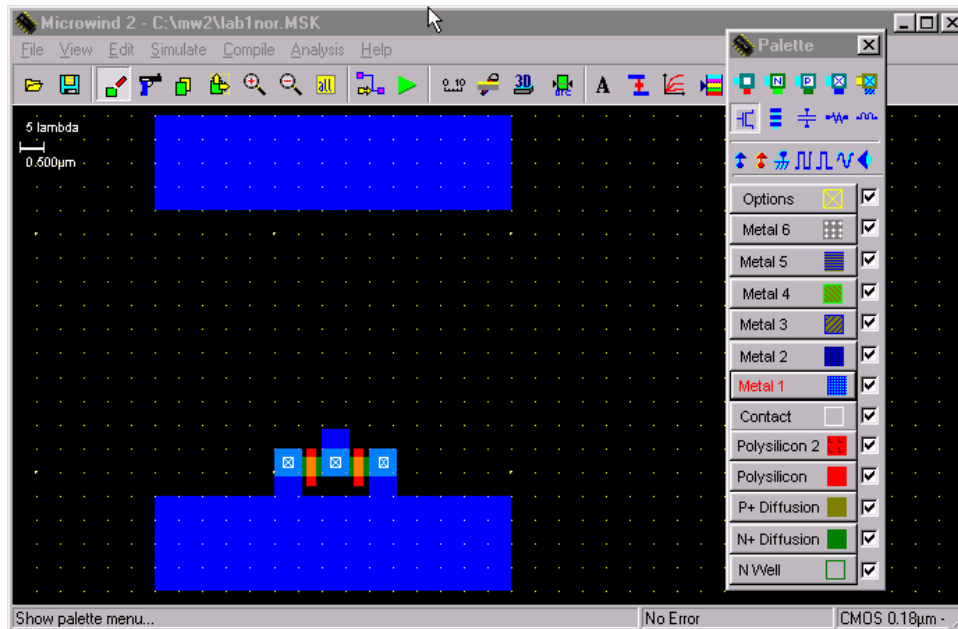

# Microwind / DSCH NOR Example: Layout

- Place the PMOs transistor on layout close to the Vdd rail on the top. To construct two PMOS transistors in series, diffusions are shifted to a side and another poly line is added as second transistor. The diffusion is shared to save area and reduce capacitance.
- The next step is to connect the inputs and the output of the two transistors.

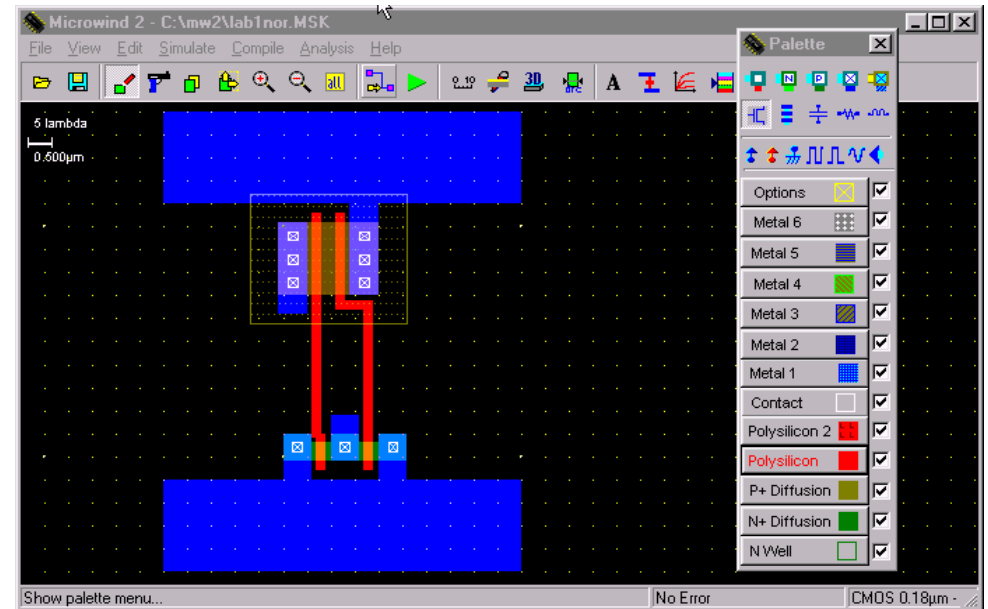
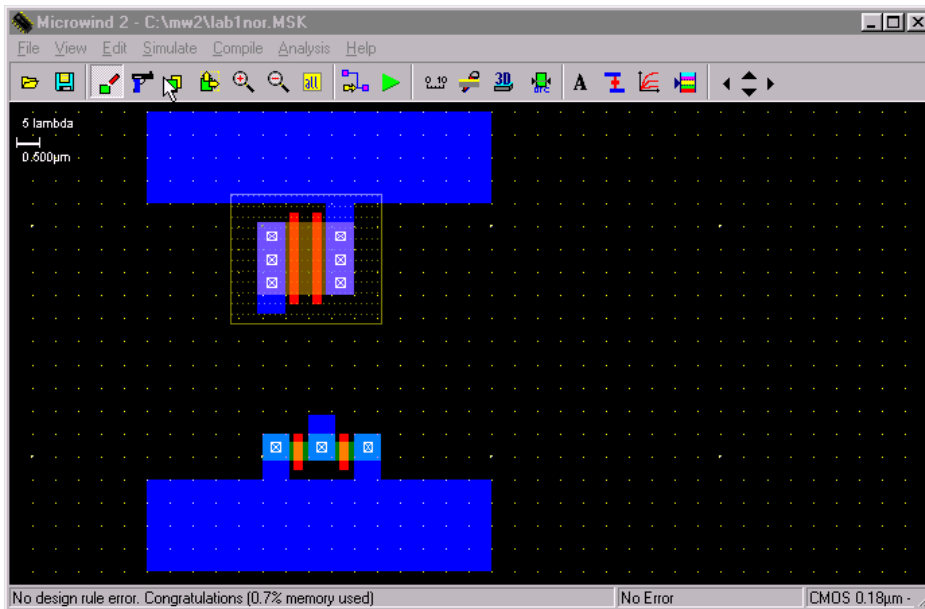

# Microwind / DSCH NOR Example: Layout

- Poly inputs are connected
- Metal output is connected.

- The next step is to connect the poly to metal1 and then to metal2. The first symbol in the first row of the palette is the poly to metal1 contact.

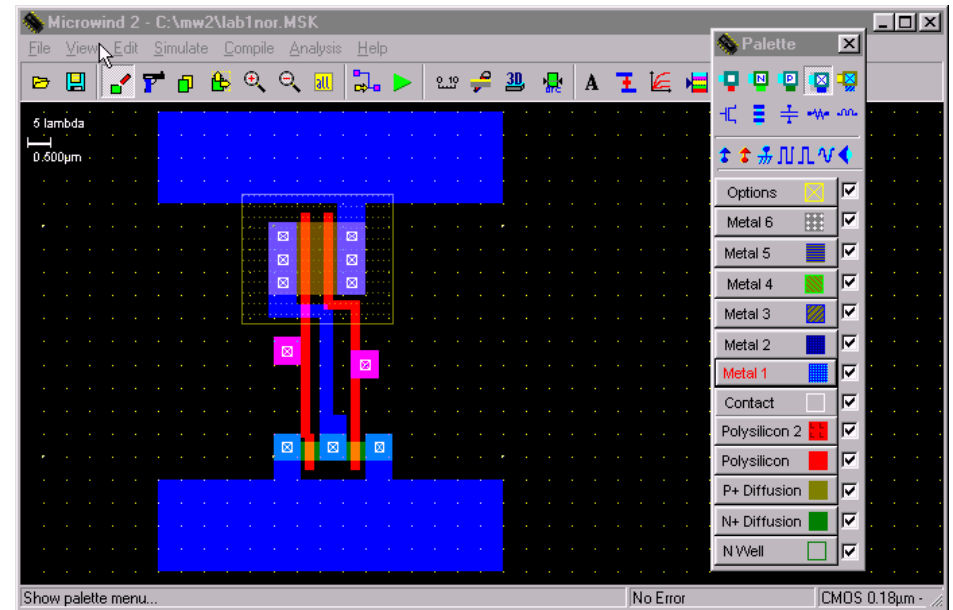
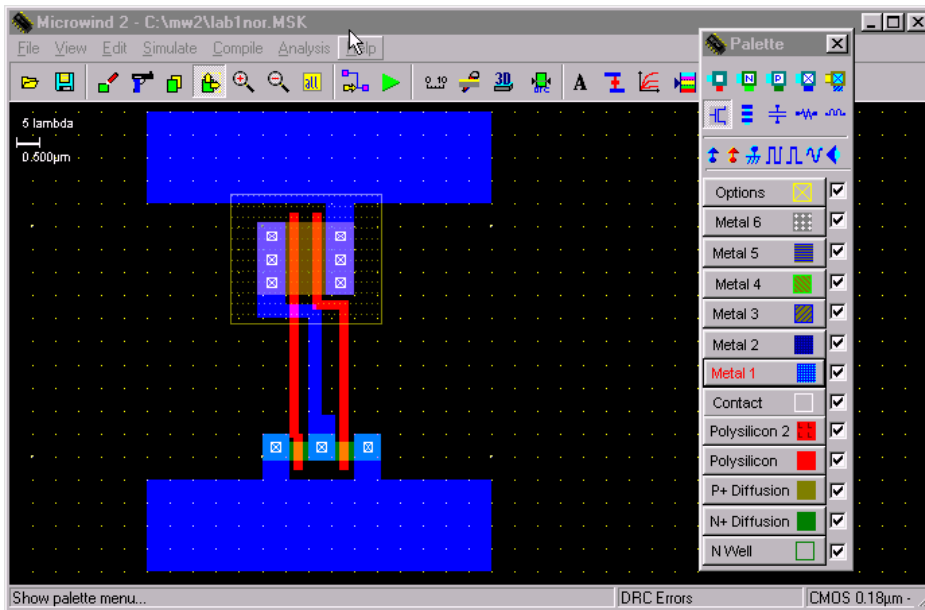



# Microwind / DSCH NOR Example: Layout

- Then we connect the metal1 to metal2 contact to the previous contact. This is the 4th contact on the first row.

- The next step is to connect the output Metal1 to Metal2. Once again use the 4th contact in the first row.

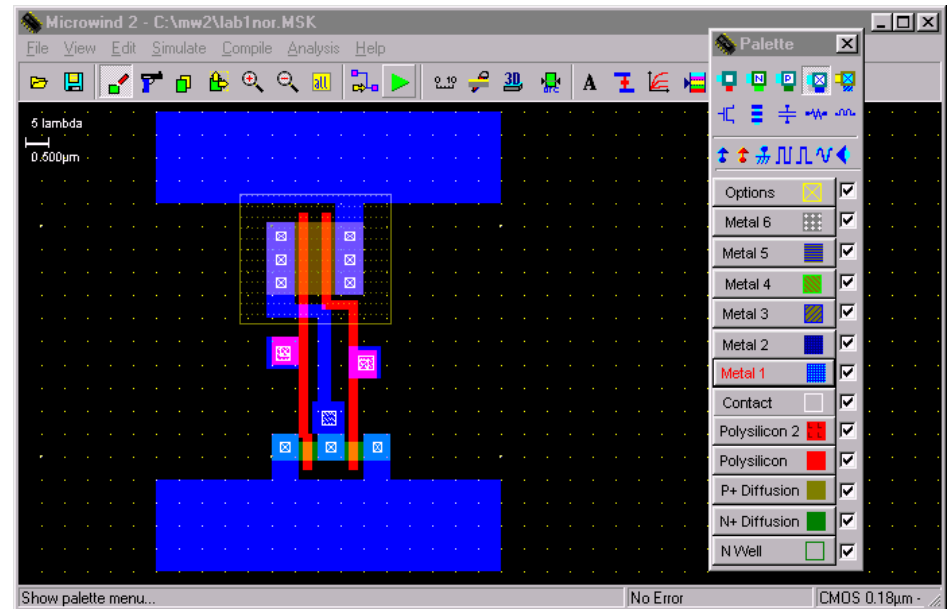
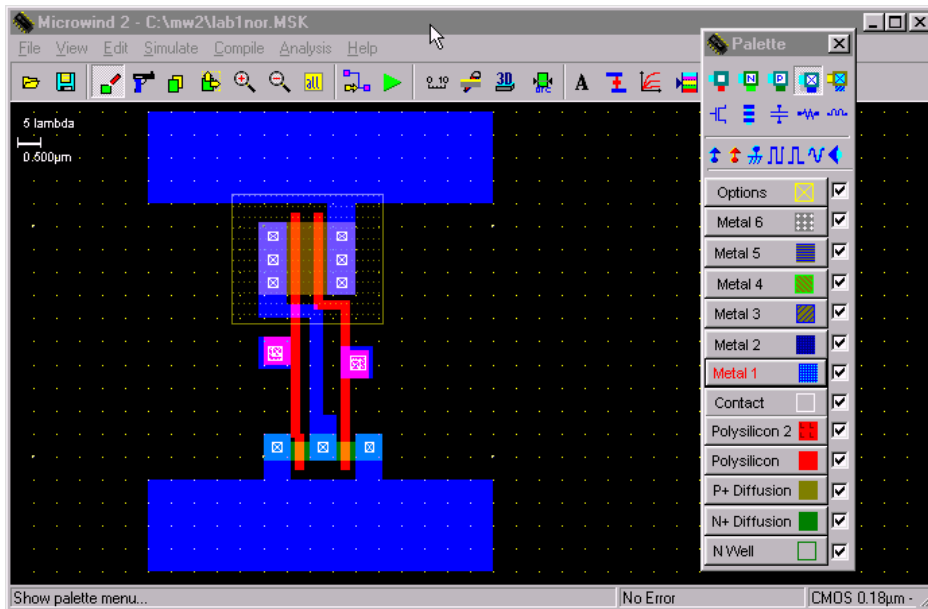

# Microwind / DSCH NOR Example: Layout

- Now we connect metal2 to the two inputs and one output and bring them to the top to go out of the cell.
- Observe the two inputs (left & right) and an output (middle) above the Vdd rail in dark blue color.

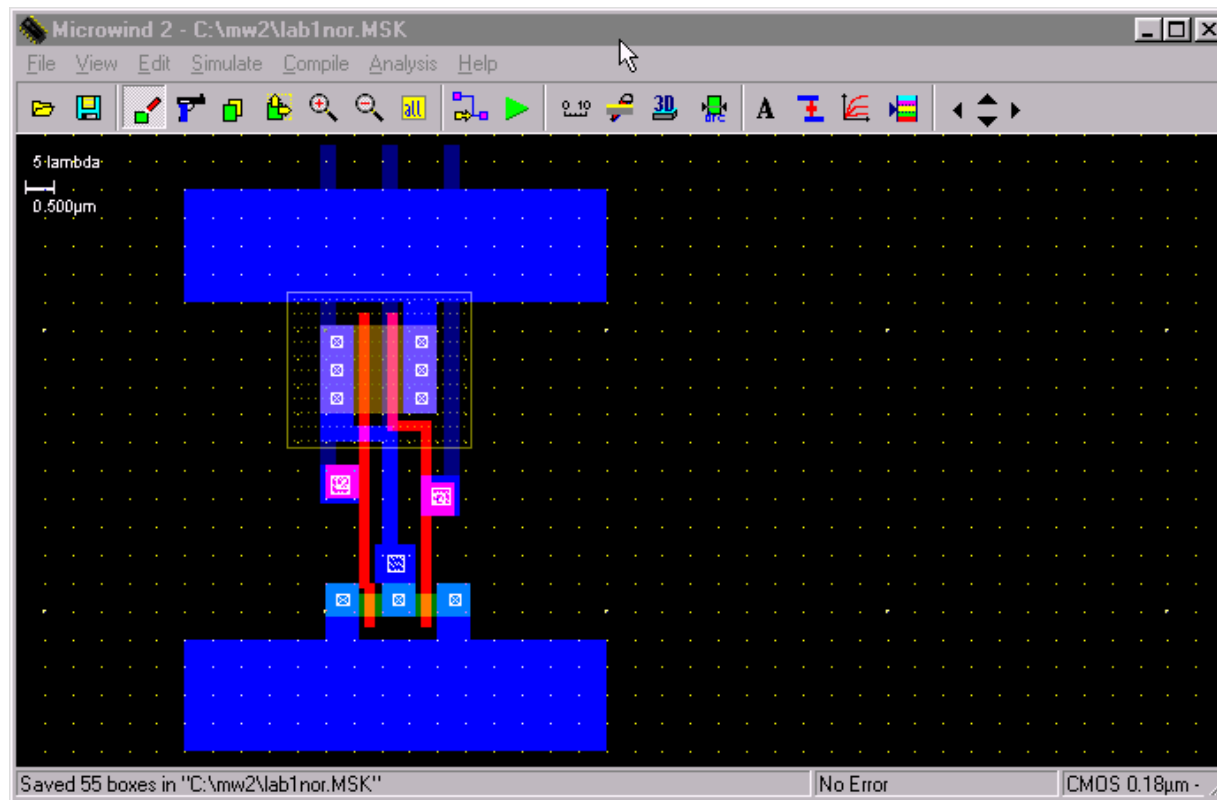

# Microwind / DSCH NOR Example: Layout

- Now we label the inputs and output as In1, In2 and out. Click on Add a Pulse Symbol in the palette (5th from the right in the 3rd row). Then click on the metal2 of one of the inputs. A window appears. Change the name of the input signal. Insert a 01 sequences and click on Insert. The click on Assign. Similarly assign the 2nd input a pulse.

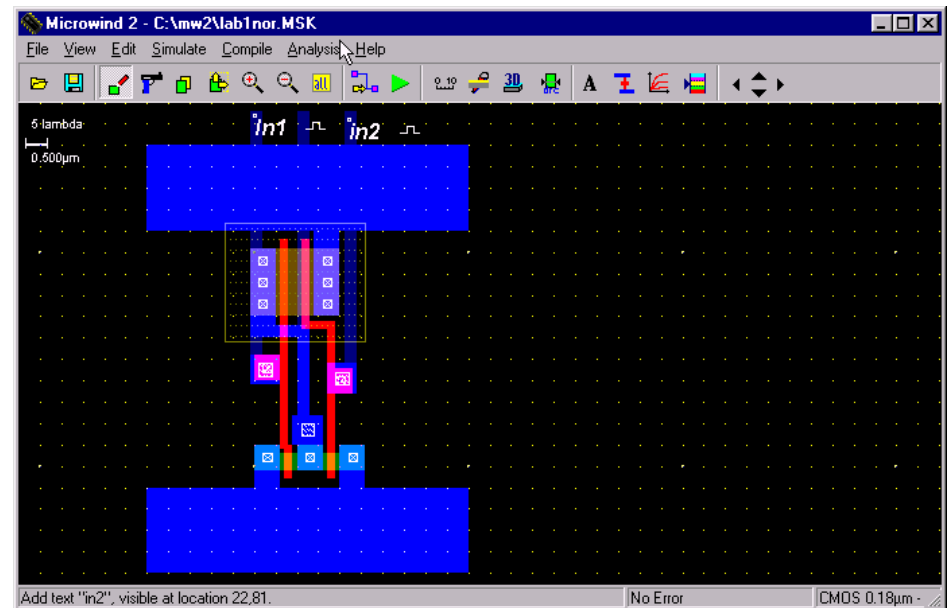
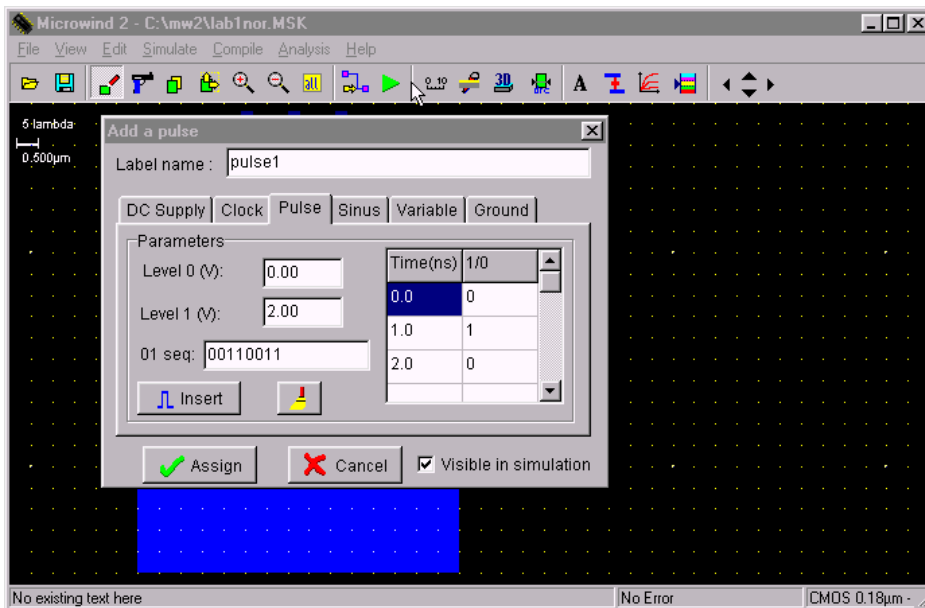

# Microwind / DSCH NOR Example: Layout

- Now select the Visible Node symbol from the palette (7th in the third row). Select it and click on the output. The 'Add a Visible Property' window appears. Change the label name to out. Select Visible in Simulation. Click on Assign. Now the output is also labeled.

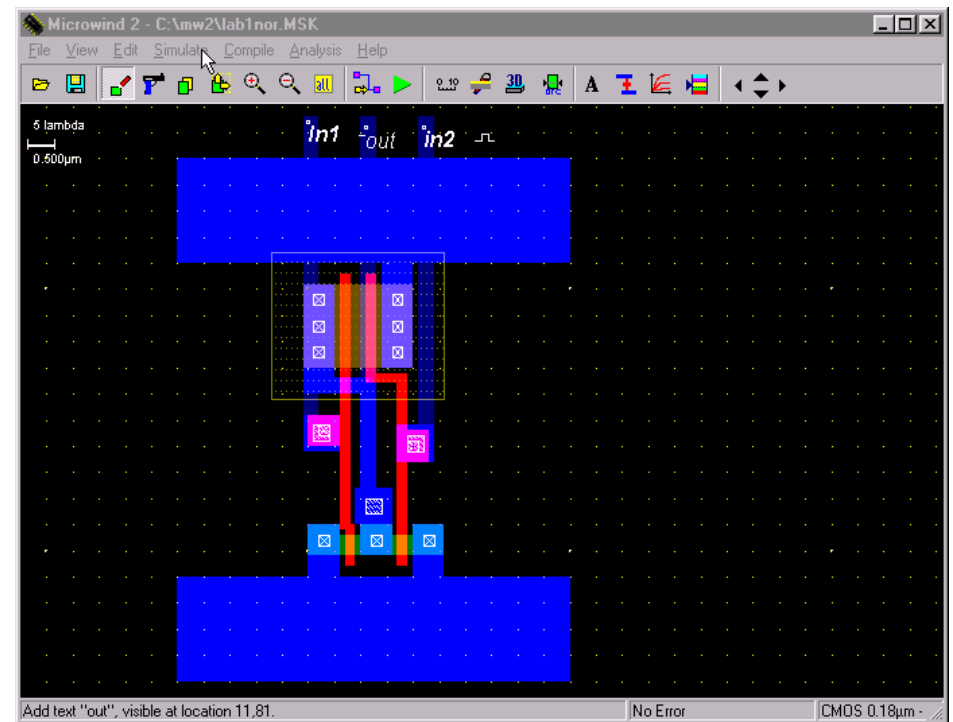
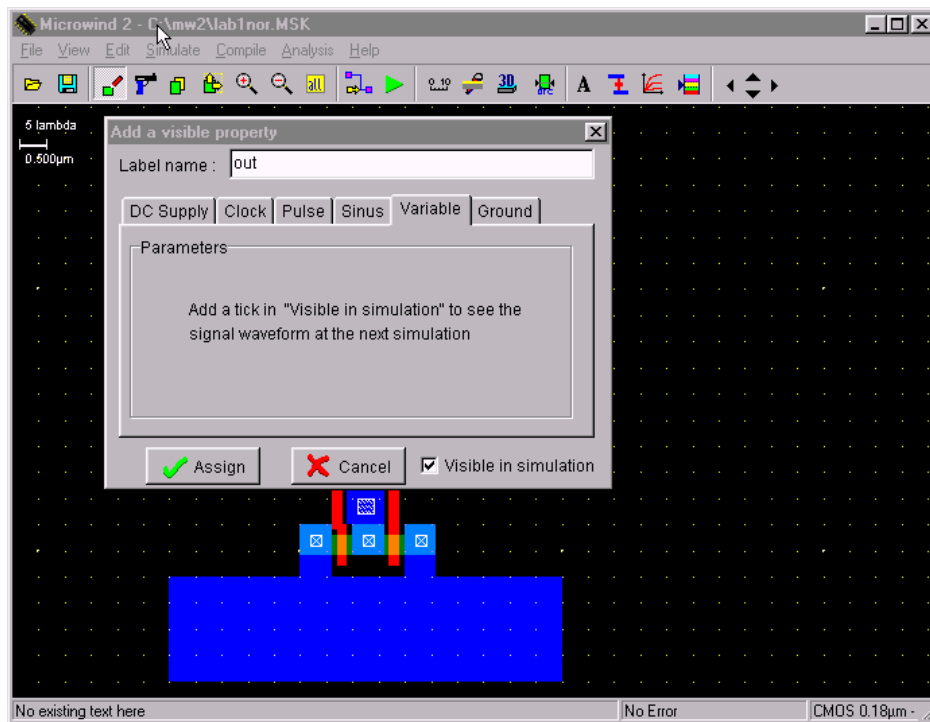

# Microwind / DSCH NOR Example: Layout

- Select *Vdd Supply* and *GND* from the palette (third row). Also click on the capacitor (3rd in 2nd row) symbol and add it to the output. Also, extend the p-well into the Vdd Rail. The click on *Edit* -> *Generate* -> *Contacts*. Select *PATH* and then in Metal choose *Metal1* and *N+ polarization*.
- To run the Simulation of your circuit, click on *Simulate* -> *Start Simulation*. Depending on the input sequences assigned at the input the output is observed in the simulation. The power value is also given.

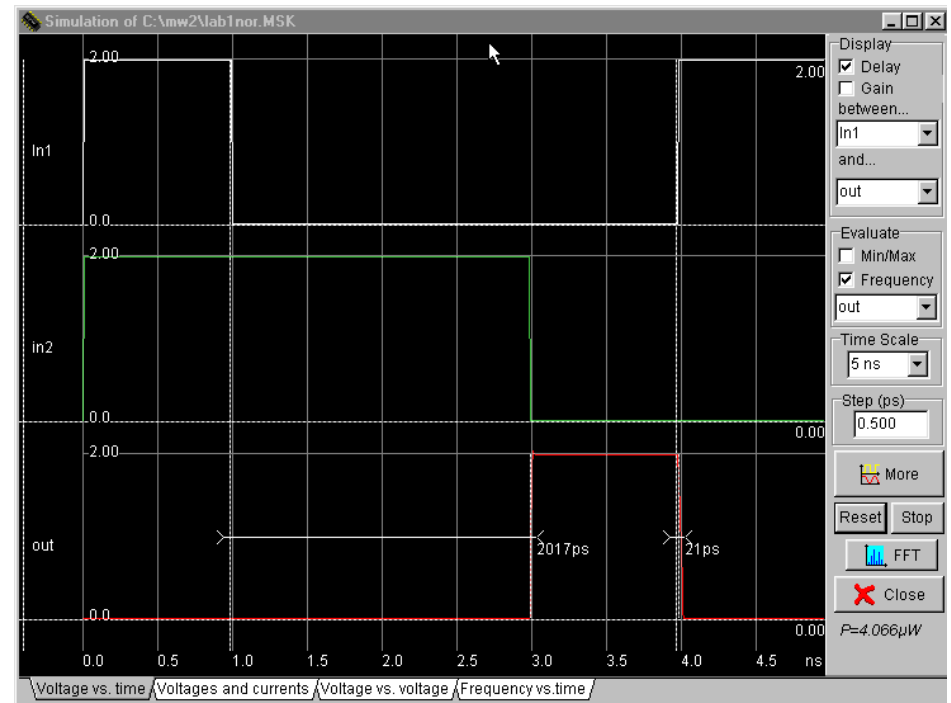
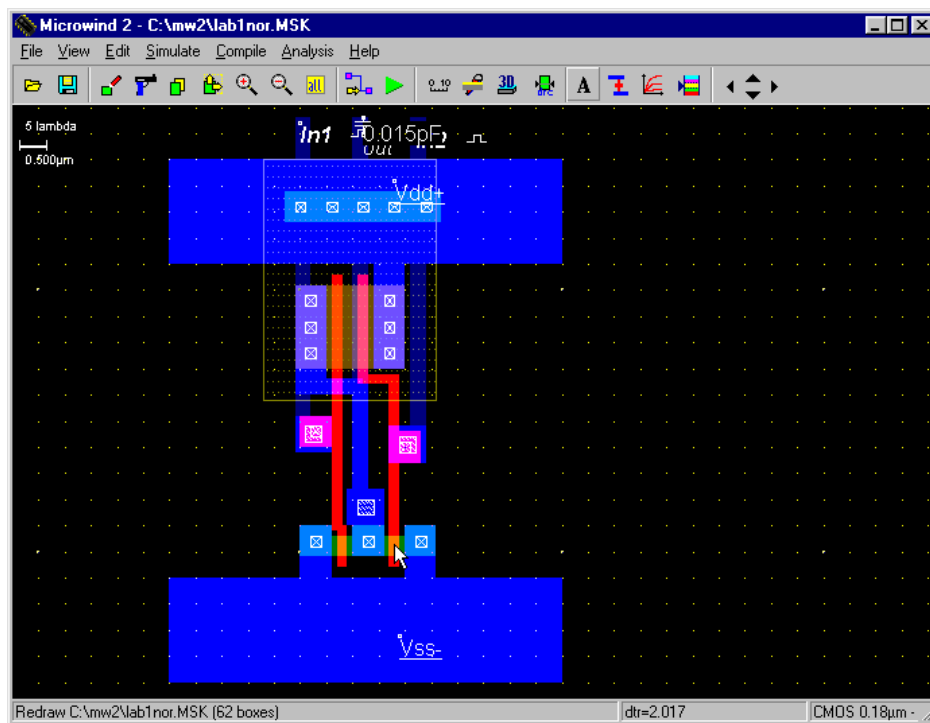

# More Reading from Microwind Site

<http://intrade.insa-toulouse.fr/~etienne/microwind/docs.html>

- Introducing basic design rules. MOS design rules, interconnect design rules, supply design rules.
- Technology influence on design rules resistance effect, capacitance effect, propagation.
- Specific design rules salicide, I<sub>dd</sub>, antenna ratio, matching, supply rules, ESD.
- Introducing CMOS 90nm technology
- A very simple four-bit microprocessor designed and simulated at gate level with DSCH3

